

CASSETTE TAPE DECK

# CT-F4040

OPERATING INSTRUCTIONS

<sup>D</sup>  
HG

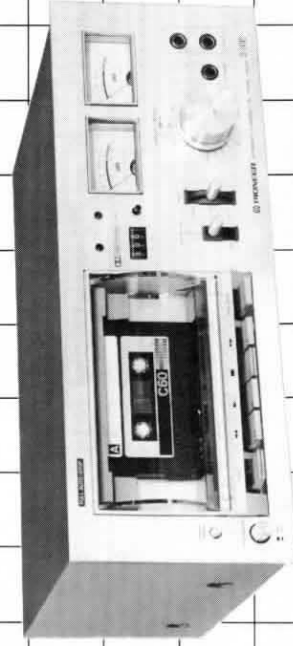

 PIONEER®

CT-F4040 are designed to operate 220V or 240V (HG model) main and 120V, 220V or 240V (D model) main. Before turning on the power, please confirm the line voltage setting indicated on the rear of your unit corresponds to the supply voltage in your area; if not, change the setting as described in Line Voltage and Rear Panels on the insertion.

## FEATURES

### Adds New Dimension to Audio Enjoyment

Fast and easy front panel operation is achieved through carefully apportioned control layout and Pioneer's original vertical cassette transport system. Simple vertical cassette loading makes handling effortless.

### Engineered for High Reliability

Tape running speed is regulated by a superbly stable DC servo controlled motor. Combined with the ultra-precision machined capstan, massive flywheel, and high precision drive belt and tape take-up mechanism, truly remarkable performance is obtained in terms of wow and flutter characteristics and stability. The cassette loading mechanism is also simple, easy to use, and precise.

### Reduced Tape Noise with Built-in Dolby\* System

Without adversely affecting the sound quality of the program source, the built-in Dolby system can significantly reduce bothersome tape hiss noise (by up to approximately 10dB at high frequencies). Wide dynamic range, excellent Signal-to-Noise ratio recording and playback can be enjoyed fully.

### Permalloy Solid Head

The recently developed high hardness Permalloy record/playback head brings out the special qualities of chrome, ferri-chrome and other types of tape. In addition to great durability against wear, the head boasts superb frequency response and Signal-to-Noise characteristics. Its high reliability makes possible high quality recordings and playback performances.

### Tape Selector with Automatic Chrome Tape Function

Independent automatic bias selector and manual equalization selector are included for deriving full performance from all types of tape, including chrome, ferri-chrome, low noise, standard, and others. When the employed cassette is provided with extra detecting holes, bias is automatically switched for chrome (CrO<sub>2</sub>) tape specifications. This advanced technology design adopts the new chrome tape equalization standard (3180 $\mu$ s + 70 $\mu$ s). Inclusion of an electronic switching circuit also eliminates noise during selection.

### Valuable Back Up Mechanisms

**Full Auto Stop:** When the tape becomes completely wound onto one reel during any operating mode (record, playback, fast forward and rewind), the transport is automatically stopped without imparting stress to the tape or mechanism.

**Illuminated Cassette Compartment:** Remaining tape quantity and tape running condition can be easily observed with a built-in illuminating lamp provided for the cassette compartment.

## CONTENTS

Features .....	2
Applications .....	3
Choosing a Location .....	3
Front Panel Facilities .....	4
Connection Diagram .....	6
Cassette Tapes .....	7
Basic Operation .....	8
Recording Steps .....	10
Recording via Microphones .....	12
Other Recording Techniques .....	12
Playback Steps .....	13
Maintenance .....	14
Employing Dolby System .....	15
Trouble-shooting Guide .....	16
Specifications, Line Voltage and Rear Panels & Schematic Diagram ...	Insertion

## APPLICATIONS

- Stereo and mono play of commercially sold pre-recorded music tapes.
- Recording from FM broadcasts and records.
- Live stereo or mono recording with microphones.

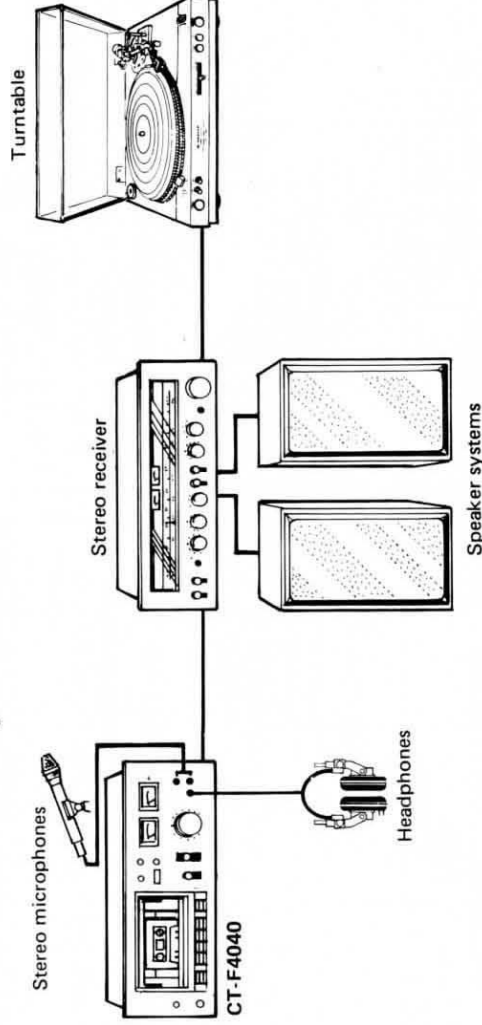

Fig. 1

### KEEP HEAD ASSEMBLY CLEAN

Since the heads, capstan and pinch roller contact the tape, they are prone to contamination by dust, tape particles, etc. Always keep these sections clean to assure top performance. Refer to Maintenance on page 14.

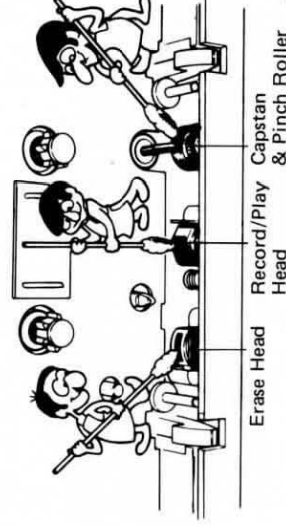

Fig. 2

## CHOOSING A LOCATION

To ensure the best sound quality and trouble-free operation, avoid setting up the tape deck in any of the locations described below.

Locations liable to downgrade performance and result in breakdowns	Resulting trouble
1. Locations exposed to direct sunlight, or near heaters or other heat sources.	1. External heat causes the performance of circuit parts to deteriorate, and operation becomes unstable.
2. Locations with poor ventilation, or with high humidity or moisture contents. Dusty locations.	2. Cause faulty contact in input/output terminals and rust. High humidity and a high moisture content cause deterioration in insulation. There is also the danger of current leakage and heat generation in circuit parts. Dust or grease in the rotating parts causes the parts to deteriorate.
3. Locations susceptible to vibration.	3. These locations affect the precision parts adversely.
4. Locations where there are thinners, benzine and other types of volatile liquids; insect sprays or any kind of inflammable material nearby.	4. These help corrode the front panel. In particular, the heads are precision-finished to micron dimensions. Chemicals may reduce their performance, so exercise all due care.





**OPERATING LEVERS**

**RECORD (REC)**

Press simultaneously with Play (▶) lever to perform recording.

**REWIND (◀◀)**

Press to rewind tape (tape travels from right to left).

**PLAY (▶)**

Press to play tape. To record, press simultaneously with REC lever (Tape travels from left to right).

**STOP (■)**

Press to stop tape and release other operating levers.

**FAST FORWARD (▶▶)**

Press for tape fast forward (tape travels from left to right).

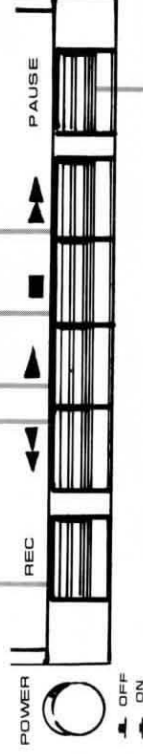

**MIC JACKS**

To employ microphones for recording, connect them to these jacks. Connect the left channel microphone to the L jack and the right channel microphone to the R jack.

**NOTE:**

*Be sure to disconnect microphones when not employing them. If they remain connected, recording cannot be performed from a source connected to the LINE (INPUT) or DIN jacks.*

**PAUSE LEVER**

Depress this lever during recording or playback to temporarily stop tape motion. Press and release the lever to resume tape motion.

**MAIN SECTIONS OF TAPE TRANSPORT**

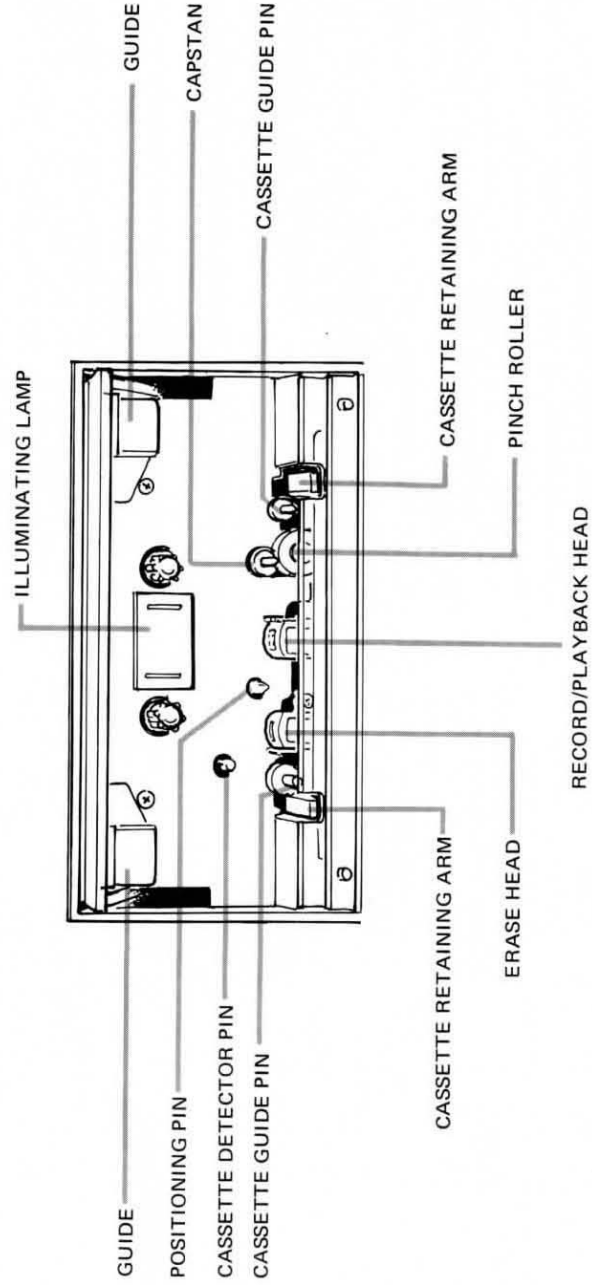

# CONNECTION DIAGRAM

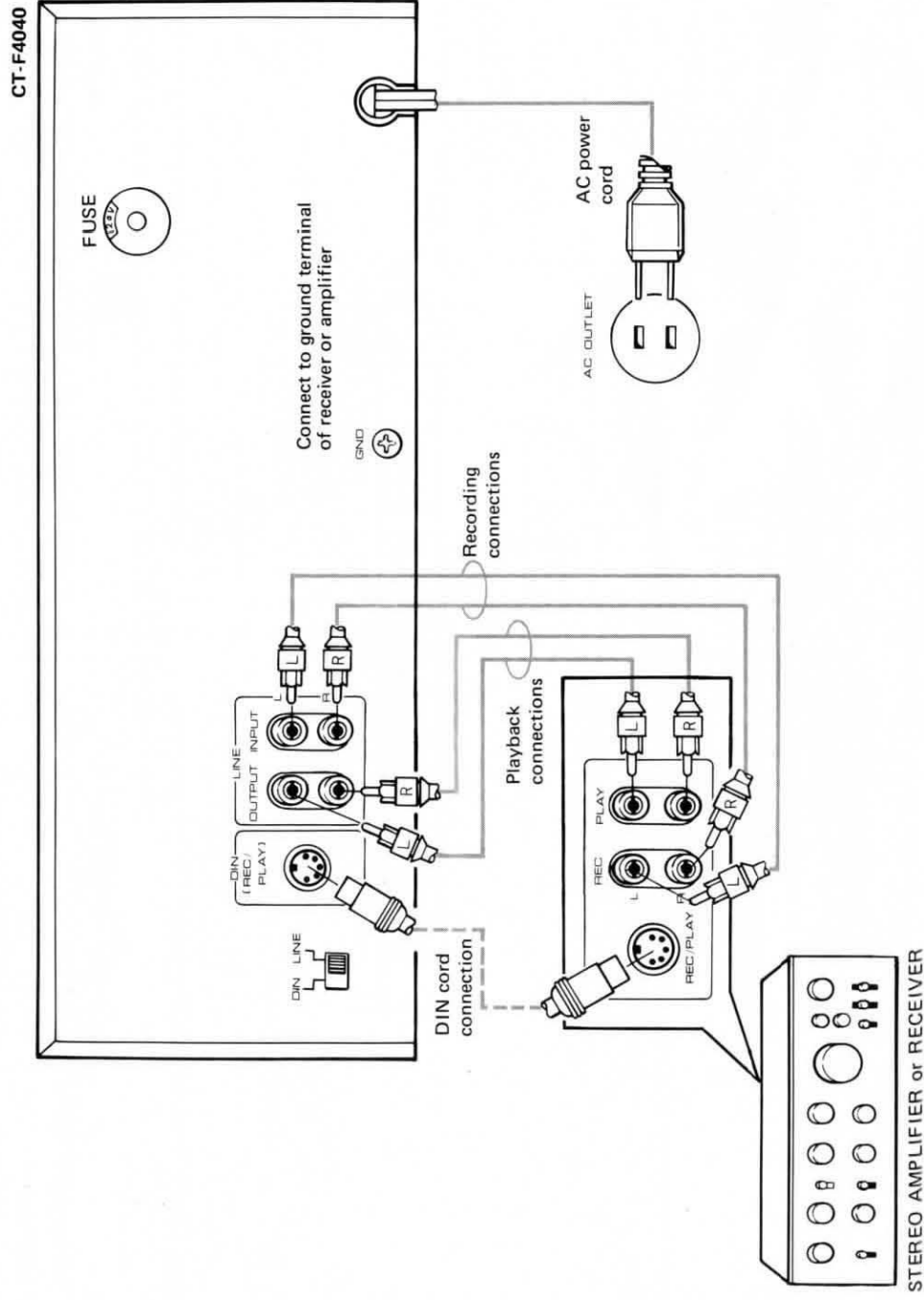

Use the accessory connecting cords to connect the CT-F4040's LINE terminals with the tape terminals on the stereo receiver or amplifier. The terminals in upper are for the left channel and those lower are for the right channel.

If you do not connect the tape deck with the other audio equipment properly, you will hear a monotonous single-pitched hum and this will impair your recording. Take care, therefore, to connect properly.

**Connections for playback:** Connect the TAPE PLAY input terminals on the stereo amplifier with the LINE OUTPUT terminals on the CT-F4040.

**Connections for recording:** Connect the TAPE REC output terminals on the stereo amplifier with the LINE INPUT terminals on the CT-F4040.

**Using the REC/PLAY connectors:** If the stereo amplifier is equipped with DIN recording/playback connectors, use DIN recording/playback cords, which are sold separately, to connect the REC/PLAY connectors on the CT-F4040 and the stereo amplifier. There is no need for the accessory connecting cords since the same connections serve for both recording and playback.

**NOTE:**

*If microphones are connected to front panel MIC jacks, a source connected to the LINE (INPUT) or DIN REC/PLAY terminals cannot be recorded.*

Set the INPUT switch to LINE if the program source to be recorded is connected to the LINE terminals, and to DIN if the source is connected to the DIN connector.

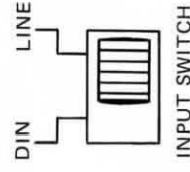

Fig. 3

## CASSETTE TAPES

Cassette tapes are manufactured according to international standards and are generally classified by tape performance and recording time.

### Performance Classifications

Table 1

Regular type	Low-noise type	High performance type
<ul style="list-style-type: none"> <li>• Standard tape</li> <li>• Dynamic tape</li> </ul>	<ul style="list-style-type: none"> <li>• Low-noise tape</li> <li>• Low-noise high-output tape</li> </ul>	<ul style="list-style-type: none"> <li>• Chrome tape</li> <li>• Ferri-chrome tape</li> </ul>

CT-F4040 can use the above types of cassette tapes by setting the tape selector switches. For details, please refer to page 11.

### Recording (Playback) Time Classifications

Table 2

RECORDING TIME (MINUTES)		CASSETTE TAPE DESIGNATION
ONE SIDE	BOTH SIDES	
15	30	C-30
30	60	C-60
45	90	C-90
60	120	C-120

Although the external dimensions of cassettes are standardized, playing and recording time differs according to tape thickness (length).

Currently C-60 and C-90 are the most commonly used. C-120 is not recommended due to excessive mechanical and electrical differences.

### CHECK CASSETTE BEFORE USE Slack or Protruding Tape

If the tape protrudes from the cassette, as shown in Fig. 4, the tape can run without passing between the capstan and pinch roller, and may possibly be damaged. Take up the slack by inserting a pencil through the reel hub and turning as indicated in Fig. 4.

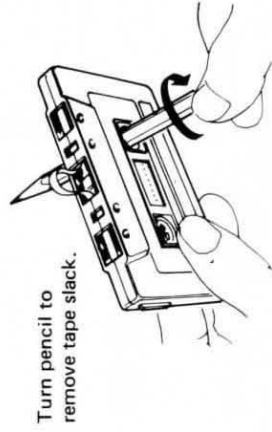

Fig. 4

**NOTE:**  
Some cassette tapes provide a tape stopper to prevent tape slacking. Be sure to take out the tape stopper before inserting the tape.

### Erase Preventing Tabs

One feature of cassette tape is the provision of erase preventing tabs, shown in Fig. 5, which can be used to prevent accidental erasure of an important recording. To protect a valuable recording, use a screwdriver or similar tool to break off the tab corresponding to the desired side of the tape. To re-record, cover the tab opening with a double layer adhesive tape (Fig. 6).

#### NOTES:

1. Since tabs are provided for each side of the tape (A & B or 1 & 2) each side can be protected individually.
2. Take care that the broken off tab does not drop inside the cassette.

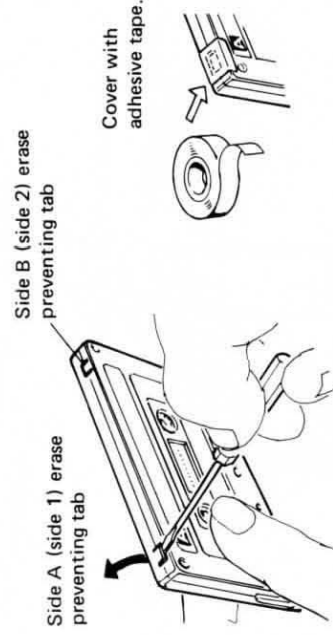

Fig. 5

Fig. 6

### POINTS WHEN HANDLING CASSETTES

#### Check Tape Before Recording

Before recording, first run the tape through fast forward and rewind. This is to prevent jamming or running irregularities from affecting the recording.

#### Allow for Leader Tape

Leader tape (which cannot be recorded) is provided at the beginning of the cassette tape. Since the leader tape takes about 5 seconds to clear the heads, allow for it when starting recording.

#### Do Not Touch Tape

Do not touch the tape surface directly by hand, since this can cause possible sound skipping.

#### Allow Heads to Dry After Cleaning

After cleaning the heads with head cleaning fluid, allow them to dry completely (2 ~ 3 minutes) before inserting a tape.

#### Cassette Storage

Avoid storing uncovered cassettes. Store them in their individual boxes to protect from dust, dirt and unwinding of the tape. Select a storage site that is free from dust, dirt, oil and magnetic fields.

# BASIC OPERATION

## TAPE SETTING AND REMOVAL

Open Door

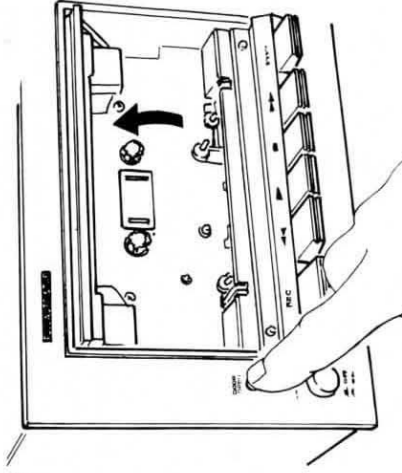

Depress the DOOR OPEN button.

Insert Cassette

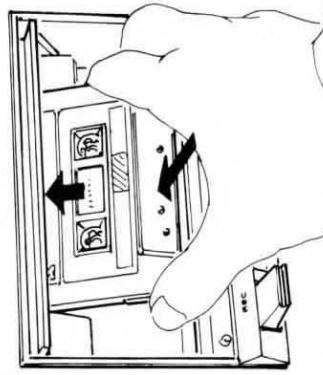

Align cassette between guides and insert carefully with an upward motion.

Close Door

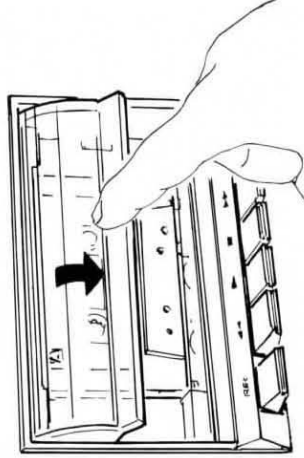

Gently slide door downward to close.

Removing Cassette



Open door and pull cassette outward.

## TAPE RUNNING

Play (▶) and Record

1. Confirm presence of tape on left reel.
2. Press Play (▶) lever (and REC lever if recording). Tape will travel from left to right.

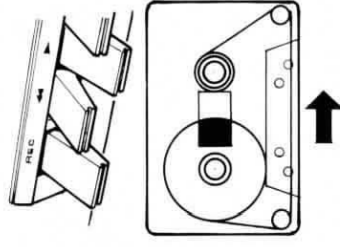

Stop (■)

Press Stop (■) lever to stop tape motion. This also releases other operating levers.

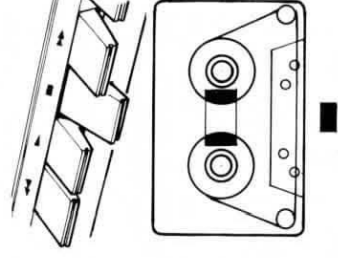

Fast Forward (▶▶)

1. Confirm presence of tape on left reel.
2. Press Fast Forward (▶▶) lever. Tape will travel from left to right at high speed.

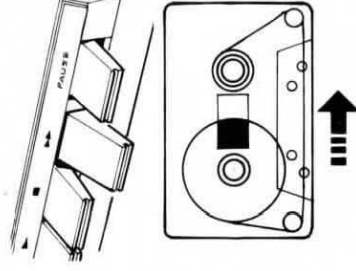

Rewind (◀◀)

1. Confirm presence of tape on right reel.
2. Press Rewind (◀◀) lever. Tape will travel from right to left at high speed.

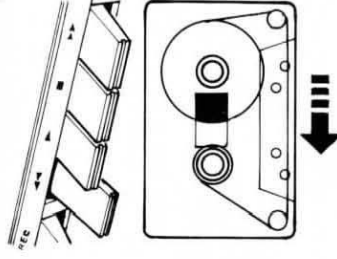

### NOTE:

Do not press more than one lever at a time, except for the Play (▶) and REC levers during recording.

### PAUSE LEVER OPERATION

1. Tape motion can be temporarily stopped during recording or playback without releasing the Play (▶) lever (and REC lever if recording) by setting the PAUSE lever to depressed position.
2. Set the PAUSE lever to undepressed position to resume tape motion.

### Typical Applications

Setting the PAUSE lever to the depressed position is convenient in situations such as the following.

- When setting the recording level.
- To skip unnecessary portions of the program source, then continue recording.
- To temporarily interrupt the sound during playback.

### NOTES:

1. Be sure to press the Stop lever to stop the tape for an extended period.
2. When recording onto previously recorded tape, operating the PAUSE lever will cause a section of the earlier sound to remain. This should be allowed for when recording.

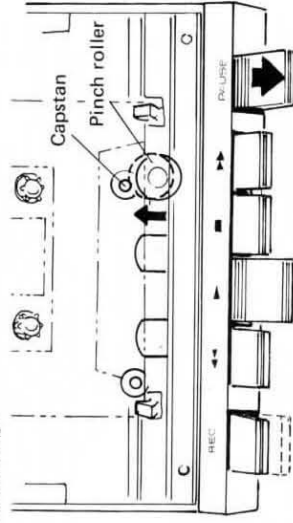

With the PAUSE lever ON (depressed), the pinch roller separates from the capstan to stop only the tape motion. Motor (capstan) and amplifier continue to operate.

Fig. 7

### AUTOMATIC STOPPING MECHANISM

Even if the Stop (■) lever is not pressed, when the tape becomes completely wound onto one reel during any operating mode (record, play, fast forward, rewind), this mechanism functions to automatically stop the tape and release the operating levers. Several seconds are required to complete this function.

### NOTE:

In the fast forward and the rewind modes, this mechanism will not operate if the PAUSE lever is depressed.

### ERASING TAPE

- Recording onto previously recorded tape automatically erases the earlier sound and replaces it with the new program source.
- To completely erase a program, turn the INPUT controls fully counter-clockwise and run the tape in recording mode.

### CHROME TAPE DETECTOR

A chrome tape detecting mechanism is incorporated into this tape deck. When the employed chrome tape is equipped with extra detecting holes, as shown in Fig. 8, bias is automatically switched for chrome tape specifications, however equalization should be selected by setting the TAPE SELECTOR switch. Be sure to use only chrome tape that is provided with these holes, since automatic switching response curves will not be performed if the holes are absent.

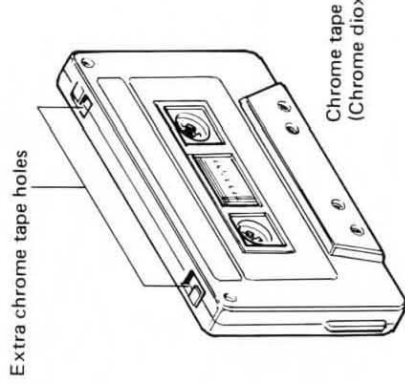

Fig. 8

### SUGGESTIONS FOR BETTER RECORDINGS

Since tape recording considerably affected by conditions external to the tape deck, adequate care is recommended regarding the following points.

#### Check Connections

Loose or incorrect connections can cause noise or recording difficulties. Inspect cords and connections before recording.

#### Tune in FM Stations Properly

Tune in station several minutes before the start of the desired program to allow the tuner time to warm up and stabilize. Best results can be obtained with a special outdoor FM antenna.

#### Inspect Records and Stylus

Before recording from records, use a good quality record cleaner to remove dust from the grooves. Also clean the stylus with a stylus brush.

#### Avoid Noise Sources

Check for possible sources of external noise which may affect the recorded sound. These include hair dryers, buzzers, refrigerator thermostats and similar electrical noise sources. Avoid using such appliances while recording is in progress.

# RECORDING STEPS

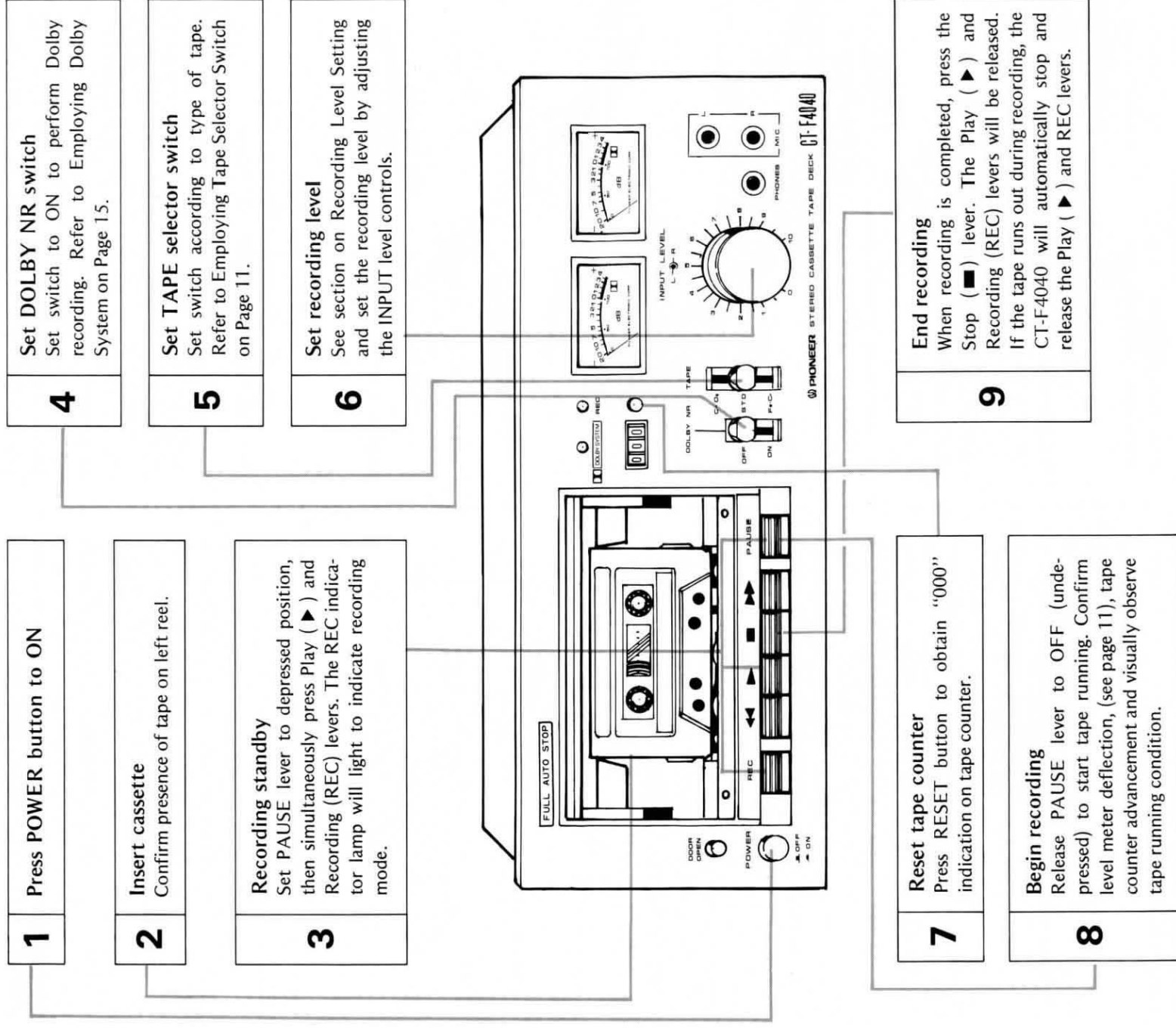



### RECORDING LEVEL SETTING

The recording level setting strongly influences the playback sound. If set so high that the level meters deflect beyond scale, distortion will be produced. Conversely, insufficient recording level results in lowered Signal-to-Noise ratio, making noise more apparent during playback. Normally set the recording level so that at high points within the program source, the level meters indicate in the range of -3dB ~ 0dB. Use care when setting, since meter deflection varies considerably according to the program source.

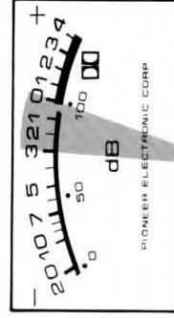

Fig. 9

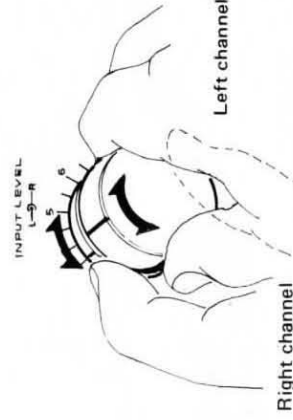

Fig. 10

Turning the controls adjusts both L and R channels at the same time. To adjust independently, hold the control you do not want to adjust and turn the control of that channel you wish to adjust.

### EMPLOYING TAPE SELECTOR SWITCH

This switch selects response characteristics according to type of tape in order to derive full tape performance and obtain low distortion recording and playback. Table 3 shows the recommended settings for popular brands of tape.

**NOTE:**

*Avoid using chrome tape that is not provided with extra detecting holes, since the automatic selector does not function if the holes are absent.*

Table 3 Major Tape Brands & Switch Settings

TAPE		SWITCH POSITION
BASF	CHROMDIOXID C-60	CrO <sub>2</sub> (Chrome)
	CHROMDIOXID C-90	
PHILIPS	CHROMIUM DIOXIDE C-60	
	CHROMIUM DIOXIDE C-90	
MAXELL	CHROME DIOXIDE C-60 (CR)	
	CHROME DIOXIDE C-90 (CR)	
TDK	KR C-60, KR C-90	
	SA-C-60	
FUJI	FC C-60, FC C-90	
SONY	C-60CR, C-90CR	
SCOTCH	CHROME C-60, C-90	
BASF	C-60LH SUPER, C-90LH SUPER	STD POSITION
	C-60, C-90	
	SUPER C-60 + 6 SUPER C-90 + 6	
AGFA	C-60, C-90 (MASTER)	
SCOTCH	LN C-60, C-90	
	UD C-60, C-90	
	UDXL C-60	
MAXELL	D C-60, D C-90	
	SD C-60, SD C-90	
	ED C-60, ED C-90	
TDK	FM C-60, FL C-60, FX C-60	
	FM C-90, FL C-90, FX C-90	
	FX DUO C-45, C-60, C-90 FX Jr. C-46, C-60, C-90	
FUJI	C-60, C-90	
	C-60HF, C-90HF	
SONY	DUAD C-60, C-90	
SONY	CLASSIC C-60	Fe-Cr POSITION (Ferri-chrome)
	CLASSIC C-90	
BASF	FERRICHROME C-60, C-90	

## RECORDING VIA MICROPHONES

### STEREO RECORDING

As shown in Fig. 11, connect a stereo type microphone or two units of the same model microphone to the L and R MIC jacks. Then proceed with recording as described in Recording Steps on Page 10.

### MICROPHONE RECORDING NOTES

- Employ dynamic or electret condenser microphones.
- Use high impedance microphones with cord lengths of less than 5 meters (about 16 ft.).
- Monitoring by headphones is suggested when recording with microphones.
- Since feedback howling can be caused when monitoring with speakers, separate microphones from speakers if using this method.

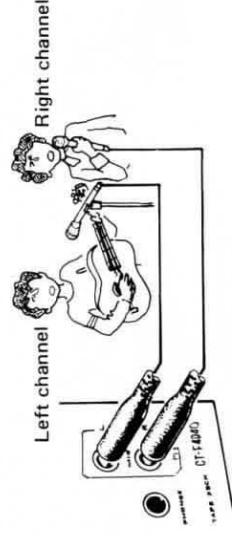

Separate microphones from speakers when recording.

Fig. 11

## OTHER RECORDING TECHNIQUES

### MONO RECORDING

- When connecting only one monophonic microphone, turn the INPUT control of the unused channel (L or R) fully counter-clockwise to minimum.
- If recording via the INPUT (REC) jacks, improved results may be obtained by connecting the mono signal to both left and right channels of the CT-F4040. This requires a separately sold connecting cord.

### MIXING BETWEEN MIC AND INPUT (REC) JACK SIGNALS

As shown in Fig. 12, a microphone signal can be recorded on the right tape track and an INPUT (REC) jack signal on the left track simultaneously (or vice versa).

1. Connect microphone to R (or L) MIC jack.
2. Connect line signal (from stereo receiver or amplifier, tuner, etc.) to L (or R) INPUT (REC) jack.
3. Proceed with recording as described in Recording Steps. Adjust recording levels separately with the L and R INPUT controls.

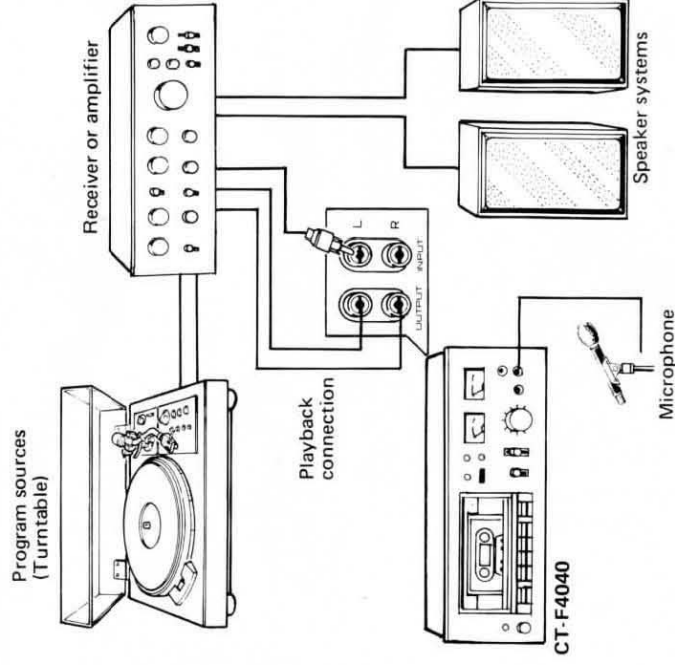
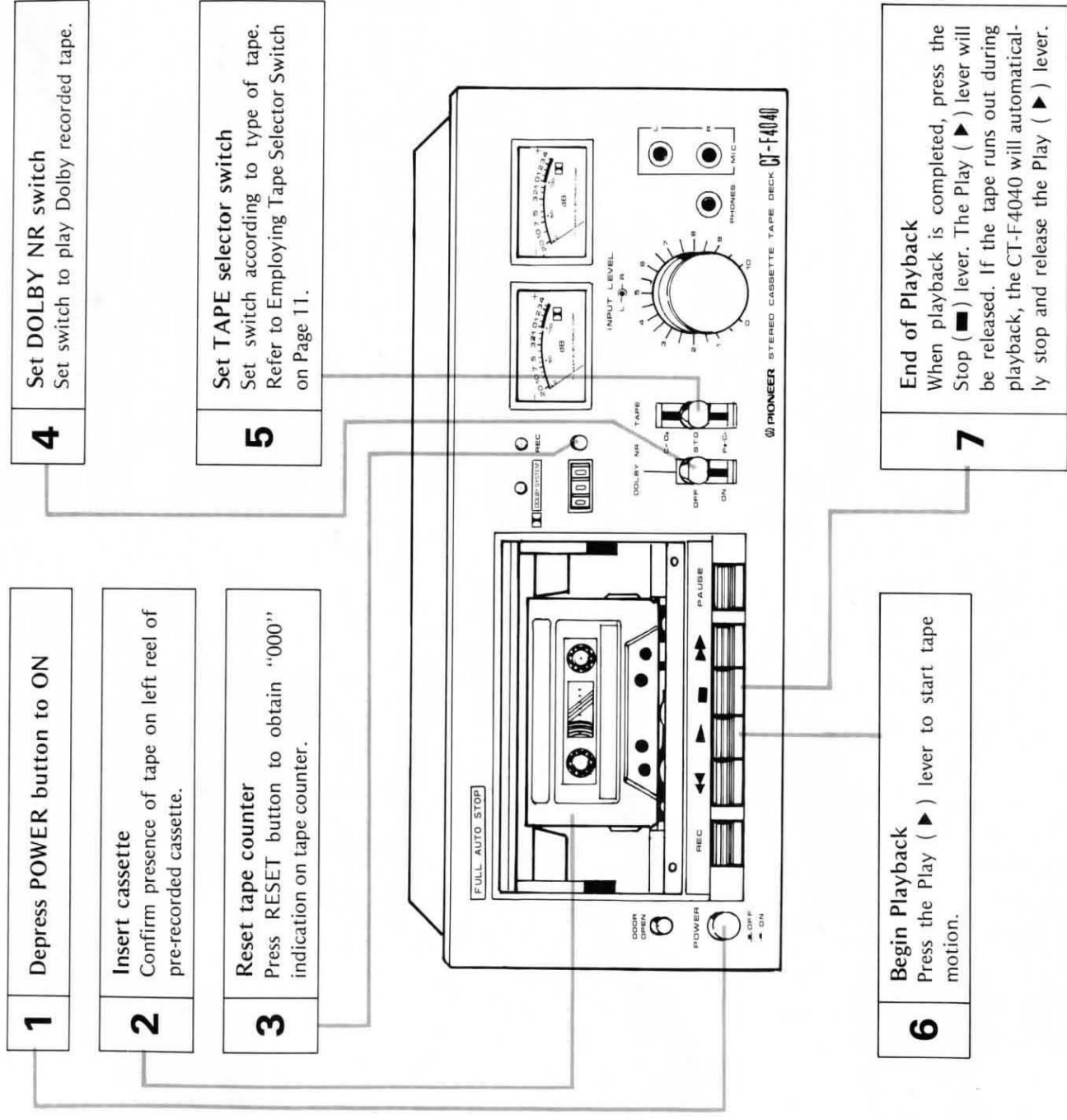

Fig. 12

## PLAYBACK STEPS



**4** **Set DOLBY NR switch**  
Set switch to play Dolby recorded tape.

**2** **Insert cassette**  
Confirm presence of tape on left reel of pre-recorded cassette.

**3** **Reset tape counter**  
Press RESET button to obtain "000" indication on tape counter.

**5** **Set TAPE selector switch**  
Set switch according to type of tape. Refer to Employing Tape Selector Switch on Page 11.

**6** **Begin Playback**  
Press the Play (▶) lever to start tape motion.

**7** **End of Playback**  
When playback is completed, press the Stop (■) lever. The Play (▶) lever will be released. If the tape runs out during playback, the CT-F4040 will automatically stop and release the Play (▶) lever.

## MAINTENANCE

Regular maintenance is important for equipment that contains rotating parts, such as cassette tape decks. The simple maintenance steps described below should be performed regularly and carefully in order to ensure continued high performance.

### HEAD ASSEMBLY CLEANING

With extensive use, dust, tape particles and other foreign matter can accumulate on the heads and capstan, which can lead to impaired sound quality and sound skipping. To prevent this, carefully clean the heads, capstan and surrounding parts at regular intervals with the accessory cleaning stick or a soft cloth.

#### Head Cleaning Steps (Fig. 13)

1. Set POWER switch to ON.
2. While using finger to hold cassette detector pin depressed, press the play lever.
3. When head section extends upward, release the cassette detector pin. Clean the pinch roller, capstan and heads.

#### NOTES:

1. Avoid bringing metallic objects, such as screwdrivers, pliers, magnets, etc. near the heads.
2. Do not use paint thinner, benzene, alcohol or other volatile liquids to clean the case and panel.

### CLEANING DOOR INTERIOR

If the inner side of the cassette door becomes soiled, clean with a soft cloth as shown in Fig. 14. To clean the upper portion of the door, fold the cloth and wedge it between the door and the upper cover, then open and close the door several times to perform cleaning.

#### NOTE:

*Static electricity may cause dust to adhere to the door during dry weather. In this case, dampen the polishing cloth slightly with water and perform cleaning.*

### HEAD DEMAGNETIZING

The heads can become slightly magnetized through long use, while they can become more strongly magnetized if magnetic objects such as magnetic tipped screwdrivers are brought into proximity with them. This can cause loss of high frequency response and induce noise into recording and playback. At regular intervals, employ a separately sold head eraser to demagnetize the heads and surrounding parts. Refer to the head eraser operating instructions for detailed information.

#### Cleaning Head Assembly

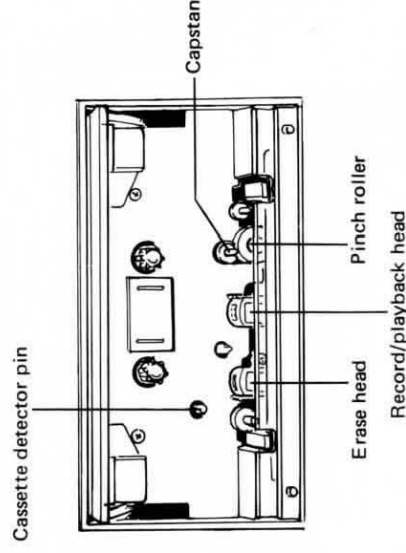

Fig. 13

#### Cleaning Door Interior

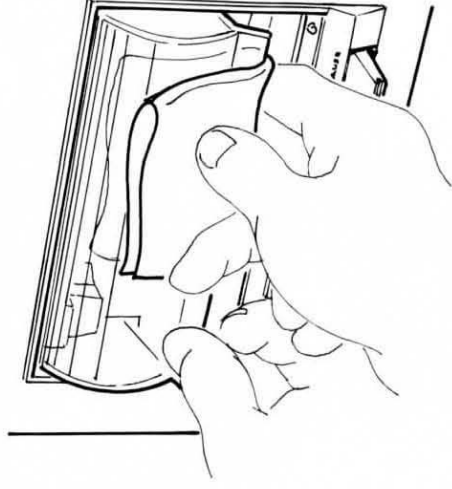

Fig. 14

## EMPLOYING DOLBY SYSTEM

The Dolby System is a method of noise reduction pertaining to noise generated in the playback process. It is currently widely employed throughout the world. As the system is mainly concerned with noise produced by the tape itself, it cannot appreciably reduce noise contained in the program source being recorded. For this reason, the signal should be as free from noise as possible in order to derive maximum benefit from the Dolby process. Noisy records or FM signals etc. should be avoided.

### PRINCIPLE

The magnetic tape employed with a tape recorder possesses a certain degree of inherent noise. Within this noise, the most easily audible is mid to high frequency hiss noise, which is considered to arise from magnetic particle size. If the magnetic particles are small, or if the tape speed is increased, which in practice is equivalent to reducing the particle size, tape hiss noise becomes reduced. The slow speed employed by cassette tape however, places it at a disadvantage in this respect.

The Dolby system (B type) built into the CT-F4040 is intended mainly for reducing this hiss noise. An A type system is also available which reduces all types of noise (employed only in special professional applications). Although the noise reduction frequency band differs, both types under optimum conditions are capable of providing up to 10dB improvement. The B type noise reduction system operates as follows. During recording, when the input signal declines below the reference level, the mid and high frequency components are successively enhanced prior to recording. The opposite process is employed during playback, i.e.: mid and high frequency components below the reference level are attenuated prior to playback. Although the signal is returned to its original form, hiss noise produced in the playback process becomes significantly reduced.

### TAPE SELECTION

The CT-F4040 does not present special requirements. Although there are some differences among standard, chrome, ferri-chrome and LH types, nearly all types of cassette tape can be employed. Caution is recommended however, regarding C-120, ultra high sensitivity LH tape, and special purpose tapes.

#### NOTE:

*The recording and playback levels of tapes sold on the market do differ from tape to tape, in which case the maximum effective of the Dolby system is not realized.*

### RECORDING LEVEL

Recording level adjustment is generally the same as with non-Dolby recordings. With wide dynamic range sources, such as live recording via microphones, it may be advisable to set the recording level lower than normal. This is because a lower level will reduce the fear of over-loading the input circuits during the loud sounds, and the signal-to-noise ratio for the quieter sounds will be improved by the Dolby effect. A slightly "low" setting thus gives you the advantage of a wider dynamic range.

### PLAYBACK

- Commercially sold pre-recorded tapes produced by the Dolby system (Dolby encoded tape) can be played via the CT-F4040 Dolby mode for low noise sound reproduction.
- The Dolby system must be applied during both recording and playback in order to provide satisfactory performance. Normal playback of Dolby recorded tape, or Dolby playback of normally recorded tape will result in unnatural frequency balance and interfere with program enjoyment.

## TROUBLE-SHOOTING GUIDE

Most cases of operating difficulty can be traced to simple causes such as improper maintenance, incorrect or loose connections, defective tape, and incorrect operating method. The following checklist is provided for correcting the most commonly experienced difficulties.

Difficulty	Probable Causes	Correction
Tape does not run	<ol style="list-style-type: none"> <li>1. AC cord not plugged in or loose</li> <li>2. Tape has run out</li> <li>3. PAUSE lever ON</li> <li>4. Cassette tape improperly inserted</li> </ol>	<ol style="list-style-type: none"> <li>1. Insert cord correctly</li> <li>2. Rewind tape</li> <li>3. Set PAUSE lever to OFF (undepressed)</li> <li>4. Remove and carefully reinsert cassette</li> </ol>
High frequencies weak	<ol style="list-style-type: none"> <li>1. Head soiled</li> <li>2. Incorrect TAPE SELECTOR switch setting during record or playback</li> <li>3. Normally recorded tape played with DOLBY NR switch ON</li> </ol>	<ol style="list-style-type: none"> <li>1. Clean heads</li> <li>2. Set TAPE SELECTOR switch to match employed tape</li> <li>3. Set DOLBY NR switch to OFF</li> </ol>
Playback sound distorted	Distortion recorded onto tape	Replace cassette
Sound unsteady	<ol style="list-style-type: none"> <li>1. Capstan soiled</li> <li>2. Cassette defective</li> </ol>	<ol style="list-style-type: none"> <li>1. Clean heads and capstan</li> <li>2. Replace cassette</li> </ol>
Excessive noise	<ol style="list-style-type: none"> <li>1. Tape old</li> <li>2. Dolby recorded tape played with DOLBY NR switch OFF</li> </ol>	<ol style="list-style-type: none"> <li>1. Replace cassette</li> <li>2. Set DOLBY NR switch to ON</li> </ol>
Cannot record	Cassette erase preventing tab broken off	Replace cassette or cover tab opening with adhesive tape
Recorded sound distorted	<ol style="list-style-type: none"> <li>1. Input level too high</li> <li>2. Heads soiled</li> </ol>	<ol style="list-style-type: none"> <li>1. Reduce input level when recording</li> <li>2. Clean heads</li> </ol>
Automatic stop functions before tape runs out	Tape slack	Tape up tape slack

Moisture forms in the operating sections of this model and the model's performance will be impaired if the model is brought from cool surroundings into a warm room or if the temperature of the room rises suddenly.

To prevent any performance impairment, let the model stand in its new surroundings for about an hour before switching it on, or ensure that the room temperature rises gradually.

### PIONEER ELECTRONIC CORPORATION

4-1, Meguro 1-Chome, Meguro-ku, Tokyo 153, Japan  
**U.S. PIONEER ELECTRONICS CORPORATION**  
 85 Oxford Drive, Moonachie, New Jersey 07074, U.S.A.

**PIONEER ELECTRONIC (EUROPE) N.V.**  
 Luithagen-Haven 9, 2030 Antwerp, Belgium  
**PIONEER ELECTRONICS AUSTRALIA PTY. LTD.**

178-184 Boundary Road, Braeside, Victoria 3195, Australia  
 Printed in Japan